

**Offertförfrågan elborstar**

FÖRETAG		KONTAKTPERSON	BEST.NR
ADRESS		POSTNR	POSTADRESS
TELEFON	FAX	E-POST	
Önskad leveransdag från Carbex ____/____ 20 ____		<input type="checkbox"/> Expressfrakt	<input type="checkbox"/> Paket <input type="checkbox"/> Brev

**BORSTDATA**

Antal borstar \_\_\_\_\_ st  
 Fabrikat \_\_\_\_\_  
 Kvalitet \_\_\_\_\_  
 Figurnr \_\_\_\_\_ + \_\_\_\_\_ + \_\_\_\_\_  
 Svart  Koppar  Silver  
 Tvillingborste Parborste

**MÅTT**

**t** Tangentiell \_\_\_\_\_ mm  
**a** Axiell \_\_\_\_\_ mm  
**r** Radiell \_\_\_\_\_ mm

**LEDARE**

Antal \_\_\_\_\_ st  
 Längd \_\_\_\_\_ mm  
 Isolering  Silicon  Glasfiber  
 Förtent ledare

**KABELSKO**

Typ \_\_\_\_\_  
 Öppning \_\_\_\_\_ mm

Skiss

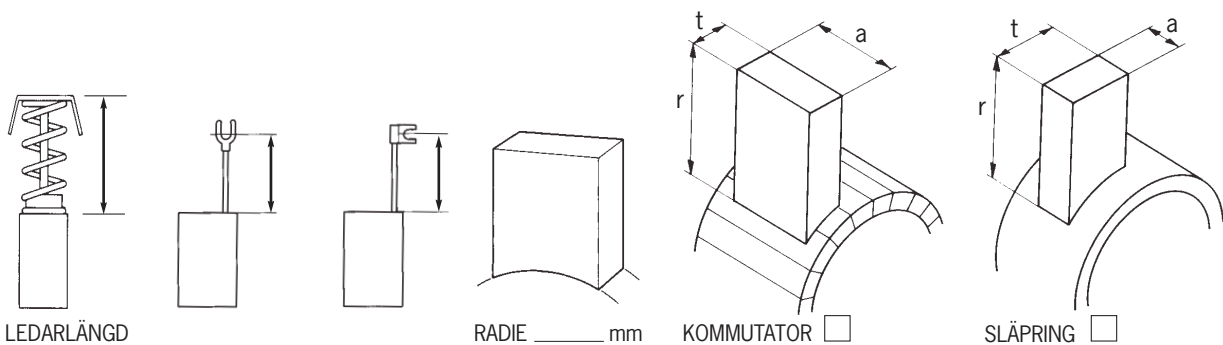

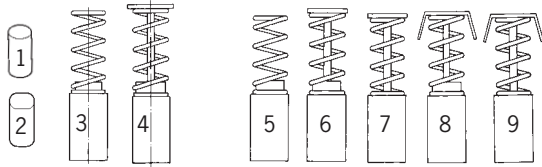

Runda borstar

Rektangulära borstar

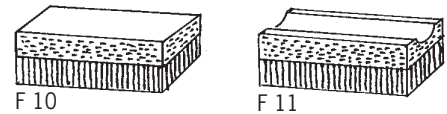
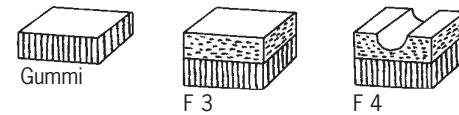
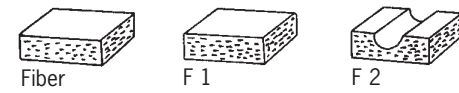
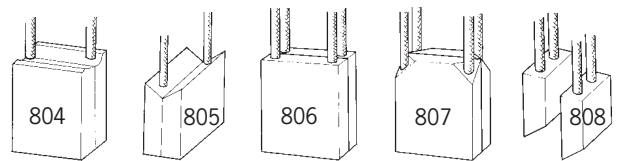
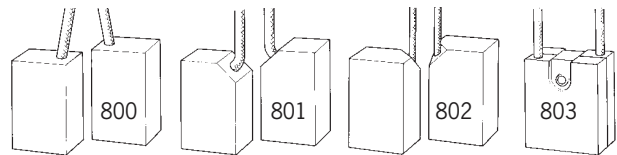
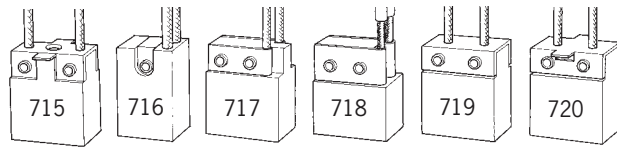
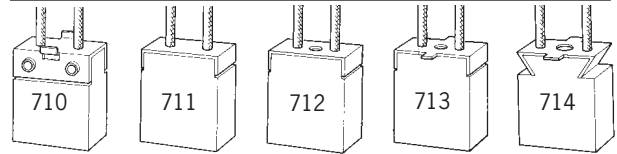
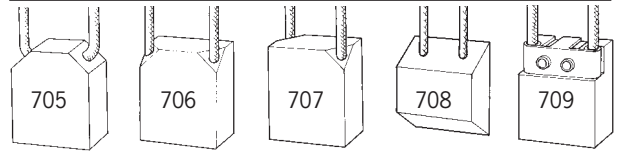
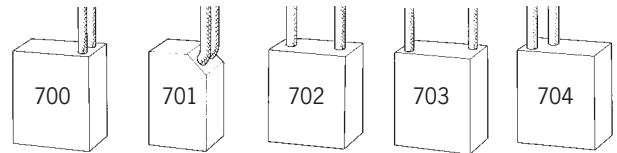
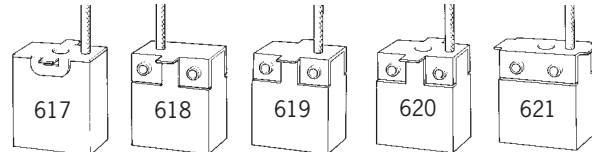
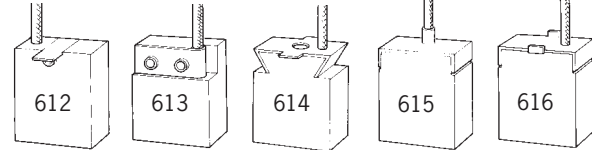
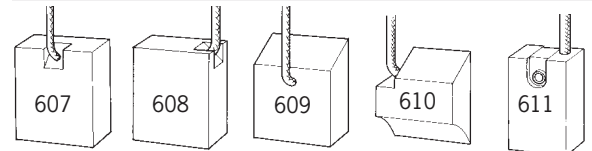
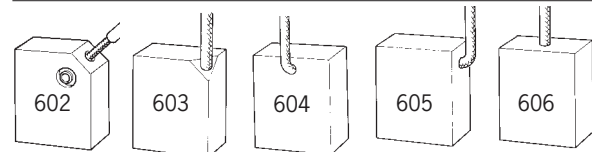
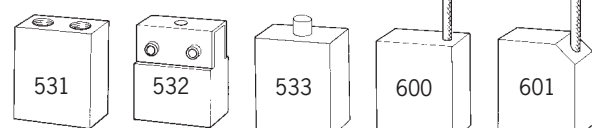
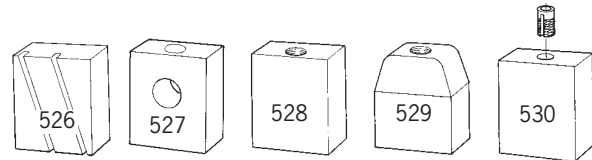
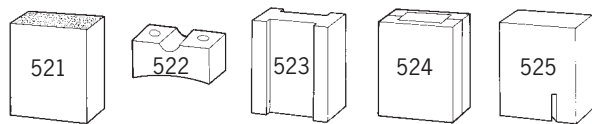
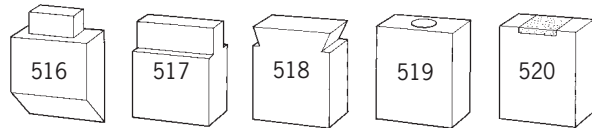
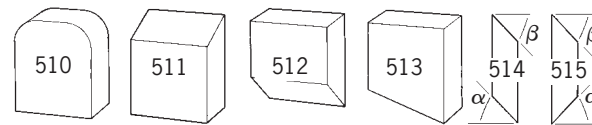
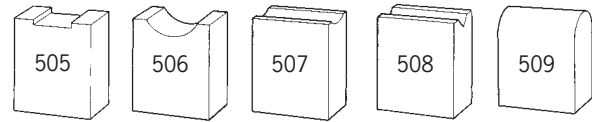
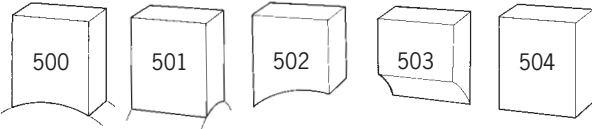

Kablarnas placering

